

Silicon PNP Planar RF Transistor

Electrostatic sensitive device.
Observe precautions for handling.



Applications

UHF oscillator and mixer stages.

Features

- High gain
- Low noise

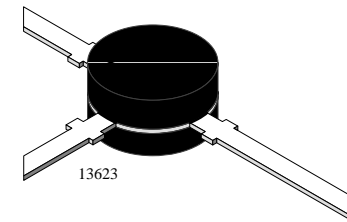
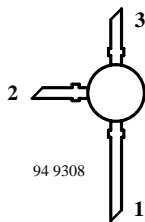

BF970 Marking: BF970

Plastic case (TO 50)

1 = Collector, 2 = Base, 3 = Emitter

Absolute Maximum Ratings

$T_{amb} = 25^{\circ}\text{C}$, unless otherwise specified

Parameter	Test Conditions	Symbol	Value	Unit
Collector-base voltage		$-V_{CBO}$	40	V
Collector-emitter voltage		$-V_{CEO}$	35	V
Emitter-base voltage		$-V_{EBO}$	3	V
Collector current		$-I_C$	30	mA
Total power dissipation	$T_{amb} \leq 60^{\circ}\text{C}$	P_{tot}	300	mW
Junction temperature		T_j	150	$^{\circ}\text{C}$
Storage temperature range		T_{stg}	-55 to +150	$^{\circ}\text{C}$

Maximum Thermal Resistance

$T_{amb} = 25^{\circ}\text{C}$, unless otherwise specified

Parameter	Test Conditions	Symbol	Value	Unit
Junction ambient	on glass fibre printed board (40 x 25 x 1.5) mm ³ plated with 35 μm Cu	R_{thJA}	300	K/W

Electrical DC Characteristics

$T_{amb} = 25^{\circ}\text{C}$, unless otherwise specified

Parameter	Test Conditions	Symbol	Min	Typ	Max	Unit
Collector cut-off current	$-V_{CE} = 40\text{ V}, V_{BE} = 0$	$-I_{CES}$			100	μA
Collector-base cut-off current	$-V_{CB} = 20\text{ V}, I_E = 0$	$-I_{CBO}$			100	nA
Emitter-base cut-off current	$-V_{EB} = 2\text{ V}, I_C = 0$	$-I_{EBO}$			10	μA
Collector-emitter breakdown voltage	$-I_C = 1\text{ mA}, I_B = 0$	$-V_{(BR)CEO}$	35			V
DC forward current transfer ratio	$-V_{CE} = 10\text{ V}, -I_C = 3\text{ mA}$	h_{FE}	25	50	90	

Electrical AC Characteristics

$T_{amb} = 25^{\circ}\text{C}$, unless otherwise specified

Parameter	Test Conditions	Sym- bol	Min	Typ	Max	Unit
Transition frequency	$-V_{CE} = 10\text{ V}, -I_C = 3\text{ mA}, f = 300\text{ MHz}$	f_T		1000		MHz
Collector-base capacitance	$-V_{CB} = 10\text{ V}, f = 1\text{ MHz}$	C_{cb}		0.4		pF
Noise figure	$-V_{CE} = 10\text{ V}, -I_C = 3\text{ mA}, Z_S = 50\ \Omega,$ $f = 800\text{ MHz}$	F		4.2	5.0	dB
Power gain	$-V_{CE} = 10\text{ V}, -I_C = 3\text{ mA}, Z_L = 500\ \Omega,$ $f = 800\text{ MHz}$	G_{pb}	13	14.5		dB
Collector current for G_{pbmax}	$-V_{CE} = 10\text{ V}, Z_L = 500\ \Omega, f = 800\text{ MHz}$	$-I_C$		5		mA

Typical Characteristics ($T_{amb} = 25^{\circ}\text{C}$ unless otherwise specified)

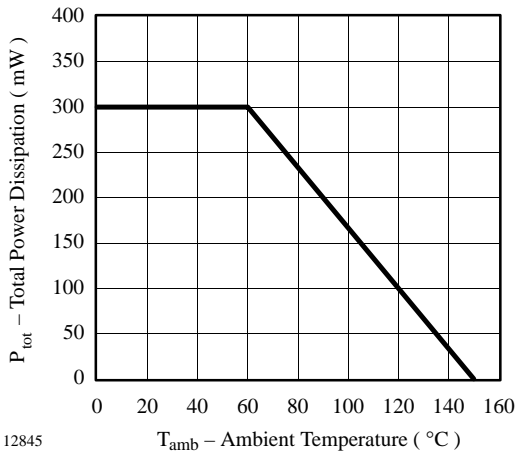

Figure 1. Total Power Dissipation vs. Ambient Temperature

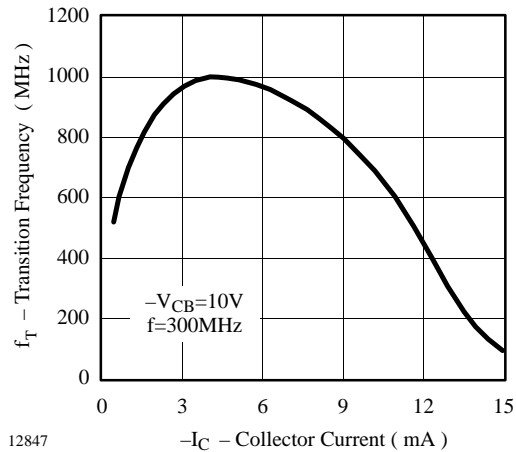
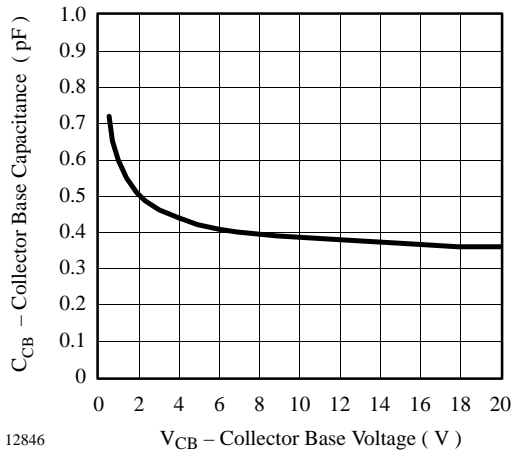

Figure 2. Transition Frequency vs. Collector Current



12846

Figure 3. Collector Base Capacitance vs. Collector Base Voltage

Dimensions of BF970 in mm

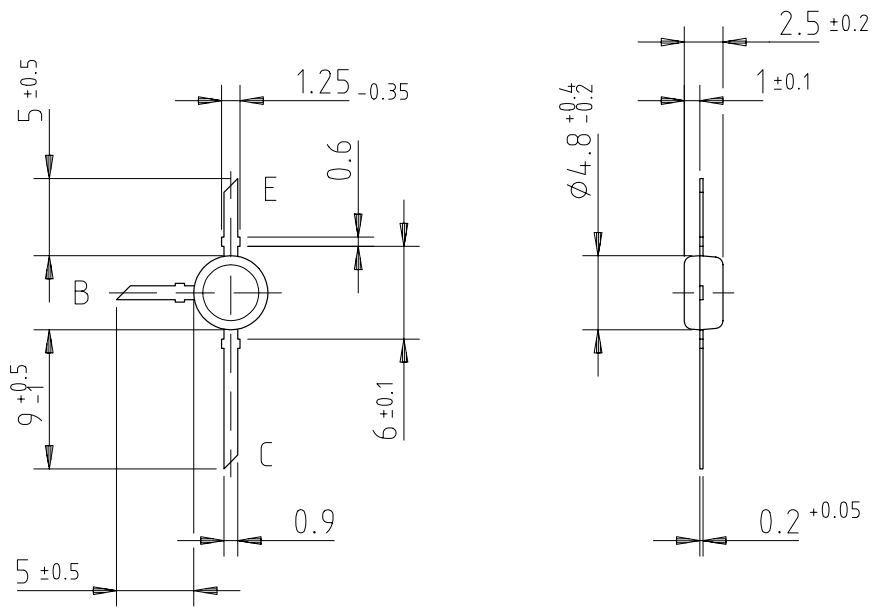

96 12243

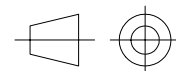

technical drawings
according to DIN
specifications

Ozone Depleting Substances Policy Statement

It is the policy of **Vishay Semiconductor GmbH** to

1. Meet all present and future national and international statutory requirements.
2. Regularly and continuously improve the performance of our products, processes, distribution and operating systems with respect to their impact on the health and safety of our employees and the public, as well as their impact on the environment.

It is particular concern to control or eliminate releases of those substances into the atmosphere which are known as ozone depleting substances (ODSs).

The Montreal Protocol (1987) and its London Amendments (1990) intend to severely restrict the use of ODSs and forbid their use within the next ten years. Various national and international initiatives are pressing for an earlier ban on these substances.

Vishay Semiconductor GmbH has been able to use its policy of continuous improvements to eliminate the use of ODSs listed in the following documents.

1. Annex A, B and list of transitional substances of the Montreal Protocol and the London Amendments respectively
2. Class I and II ozone depleting substances in the Clean Air Act Amendments of 1990 by the Environmental Protection Agency (EPA) in the USA
3. Council Decision 88/540/EEC and 91/690/EEC Annex A, B and C (transitional substances) respectively.

Vishay Semiconductor GmbH can certify that our semiconductors are not manufactured with ozone depleting substances and do not contain such substances.

We reserve the right to make changes to improve technical design and may do so without further notice.

Parameters can vary in different applications. All operating parameters must be validated for each customer application by the customer. Should the buyer use VishaySemiconductors products for any unintended or unauthorized application, the buyer shall indemnify Vishay-Semiconductors against all claims, costs, damages, and expenses, arising out of, directly or indirectly, any claim of personal damage, injury or death associated with such unintended or unauthorized use.

Vishay Semiconductor GmbH, P.O.B. 3535, D-74025 Heilbronn, Germany
Telephone: 49 (0)7131 67 2831, Fax number: 49 (0)7131 67 2423

This datasheet has been download from:

www.datasheetcatalog.com

Datasheets for electronics components.